

SAFETY GUIDE BASIC FACTORS FOR THE SELECTION, INSTALLATION AND MAINTENANCE OF HOSE AND HOSE ASSEMBLIES

Hydraulic hose (and hose assemblies) has a limited life dependent on service conditions to which is applied.

Subjecting hose (and hose assemblies) to conditions more severe than the recommended limits significantly reduce service life. Exposure to combinations of recommended limits (i.e., continuous use at maximum rated working pressure, maximum recommended operating temperature and minimum bend radius) will also reduce service life.

WARNING: FAILURE TO FOLLOW PROPER SELECTION, INSTALLATION AND MAINTENANCE PROCEDURES BODILY INJURY, AND DAMAGE TO PROPERTY.

1. SELECTION

The following is a list of factors which must be considered before the selection of a hose can be made:

1.1 Line size

In order to achieve maximum efficiency in a hydraulic system, it is necessary to keep pressure losses (resistance to the volumetric flow) to a minimum when a fluid is conveyed by the different types of flow lines.

When a fluid flows through a flow line, heat is generated by friction. Thus part of the energy is lost as heat energy, which results in a pressure loss.

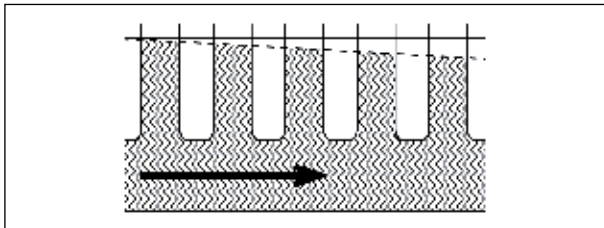

These pressure losses depend upon:

- flow velocity (for a given volumetric flow, the fluid flow velocity increases with a decrease in the cross sectional area of a flow line and vice versa)
- length of the flow line
- the viscosity of the fluid flowing
- the density of the fluid flowing
- the type of flow (laminar or turbulent)

Types of flow - The type of flow changes from laminar to turbulent at a certain flow velocity. This velocity is given by the Reynold's Number Re .

For cylindrical flow lines the following formula applies:

$$Re = \frac{v \times d}{\nu}$$

where: v = velocity (m/s)
 d = flow line internal dia (m)
 ν = kinematic viscosity (m²/s)

As soon as the value for Re exceeds 2300, the laminar flow changes to turbulent flow.

Laminar flow - In laminar flow, the individual fluid particles move up to certain speeds in uniform layers alongside each other. They scarcely disturb or influence each other.

Turbulent flow - If the value for Re exceeds 2300, flow becomes whirling and turbulent. The individual particles no longer move in one direction in an orderly fashion, but influence and hinder each other.

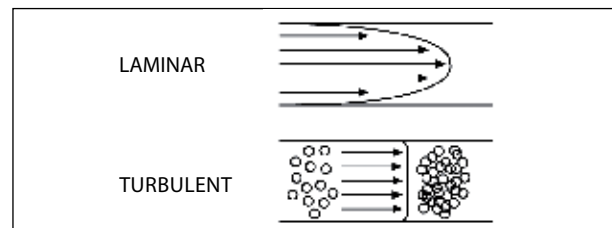

Certain fluid flow velocities have proved to be most suitable for hydraulic flow lines.

Recommended flow velocities:

Suction lines:	0.5 ... 1.2 m/s	1.6 ... 4 feet/s
Return lines:	2 ... 3 m/s	6.5 ... 10 feet/s
Pressure lines:	4 ... 7.5 m/s	13...25 feet/s

FLOW CAPACITY NORMOGRAM

Flow Capacities of Hose at Recommended Flow Velocities
 The chart below is provided as an aid in the determination of the correct hose size.

Example at 45 l/min, what is the proper hose size within the recommended velocity range for pressure lines?

Locate 45 l/min in the left-hand column and 7,5 m/s in the right-hand column (the maximum recommended velocity range for pressure lines).

Lay a straight line across these two points. The inside diameters shown in the centre column is above 9,5 mm so we have to use 12,7 mm (1/2"). For suction hose, follow the same procedure except use recommended velocity range for intake lines in the righthand column.

where: Q = flow in liters per seconds (l/sec)

V = velocity in meters per seconds (m/s)

d = hose inside diameter (mm & dash size)

TECHNICAL INFORMATION – NORMOGRAM OF THE FLOW

The normogram herewith is pivotal to help you find the hose diameter by knowing the liquid flow and speed. In order to find the correct diameter you should trace a line between the flow value (l/min) and the suggested speed (m/sec) according to the kind of delivery (pressure or return). The value touched by the line in the central column will indicate the hose ID (mm/inches) that must be used.

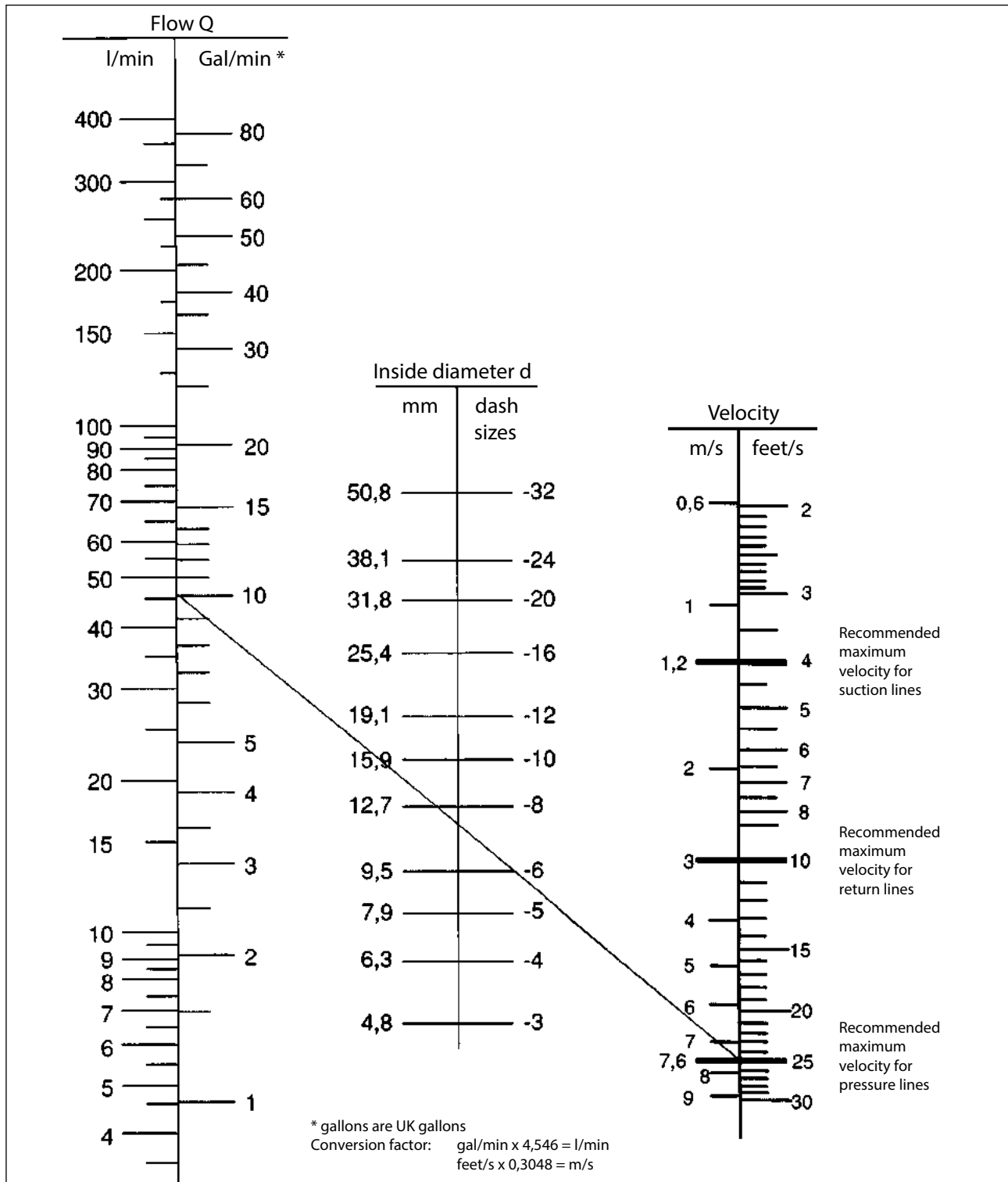

It is therefore important to calculate correctly the required flow line sizes. Undersized pressure lines results in high fluid velocity causing an excessive pressure drop, and heat built up, which impair overall system performance.

Undersized suction lines can cause cavitation at the hydraulic pump inlet, affecting performance, shortening pump life, and creating excessive noise levels.

The flow capacity normogram is an aid to determine the correct hose internal diameter size, desired flow rate and recommended velocity. By the use of any two known factors, the third can be determined.

1.2 Pressure

After determining the system pressure for a hydraulic system, hose selection must be made so that the recommended maximum operating pressure specified by a given hose, is equal or greater than the system pressure. Dynamic pressure is common for all hydraulic systems. Pressure surges which exceed the maximum working pressure (pressure relief valve setting) affect the service life of system components, including a hose assembly and therefore need to be taken into consideration. Hoses used for suction lines must be selected to ensure the hose will withstand the negative pressure of the system.

1.3 Temperature

Care must be taken to ensure that the operating temperature of the fluid being conveyed and ambient temperatures, do not exceed the limitations of the hose. Special care must be taken when routing near hot manifolds or molten metal.

1.4 Fluid Compatibility

Hose selection must assure compatibility of the hose tube, cover, reinforcement, and fittings with the fluid used.

Additional caution must be observed in hose selection for gaseous applications. Some fire resistant fluids require the same hose as petroleum oil. Some use a special hose, while a few fluids will not work with any hose at all.

For gas application, where compatible with Alfacomma Hoses, and at pressure above 10 bar, the hose cover shall be pin-pricked.

1.5 Permeation

Permeation (that is, seepage through the hose) will occur from inside the hose to outside when hose is used with gases, liquid and gas fuels, and refrigerants (including but not limited to such materials such as helium, fuel oil, natural gas or freon). This permeation may result in high concentrations of vapours which are potentially flammable, explosive, or toxic and in loss of fluid. Even though the fluid compatibility is acceptable, you must take into account the fact that permeation will occur and could be hazardous. Permeation of moisture from outside the hose to inside the hose will also occur. If this moisture permeation would have detrimental effects (particularly but not limited to refrigeration and air conditioning systems), incorporation of sufficient drying capacity in the system or other appropriate system safeguards should be selected and used.

1.6 Routing

Attention must be given to optimum routing to minimise inherent problems. Restrain, protect or guide hose with the use of clamps if necessary to minimise risk or damage due to excessive flexing, whipping or contact with other moving parts or corrosives. Determine hose lengths and configurations that will result in proper routing and protection from abrasion, snagging or kinking and provide leak resistant connections.

1.7 Environment

Care must be taken to ensure that the hose and fittings are either compatible with or protected from the environment to which they are exposed. Environmental conditions including but not limited to ultraviolet light, heat, ozone, moisture, water, salt water, chemicals, and air pollutants can cause degradation and premature failure and, therefore, must be considered.

1.8 Mechanical Loads

External forces can significantly reduce hose life. Mechanical loads which must be considered include excessive flexing, twist, kinking, tensile or side loads, bend radius, and vibration. Use of swivel type fittings or adaptors may be required to ensure no twist is put into the hose. Unusual applications may require special testing prior to hose selection.

1.9 Abrasion

While a hose is designed with a reasonable level of abrasion resistance, care must be taken to protect the hose from excessive abrasion which can result in erosion, snagging, and cutting of the hose cover. Exposure of the reinforcement will significantly accelerate hose failure.

1.10 Proper End Fitting

Care must be taken to ensure proper compatibility exists between the hose and coupling selected based on the manufacturer's recommendations substantiated by testing to industry standards such as SAE J517, DIN 20024, JIS B 8360.

1.11 Length

When establishing proper hose length, motion absorption, hose length changes due to pressure, as well as hose and machine tolerances must be considered.

1.12 Specifications and Standards

When selecting hose and fittings, government, industry, and manufacturer's specifications and recommendations must be reviewed as applicable.

1.13 Hose Cleanliness

Hose components may vary in cleanliness levels. Care must be taken to ensure that the assemblies selected have an adequate level of cleanliness for the application.

1.14 Welding and Brazing

Heating of plated parts, including hose fittings and adaptors, above 232° C (450° F) such as during welding, brazing, or soldering may emit deadly gases.

1.15 Electrical Conductivity

Certain applications require that a hose be non-conductive to prevent electrical current flow. Other applications require the hose to be sufficiently conductive to drain off static electricity. Extreme care must be exercised when selecting hose and fittings for these or any other applications in which electrical conductivity or non-conductivity is a factor. For applications that require hose to be electrically non-conductive, including but not limited to applications near high voltage electric lines, only special non-conductive hose is to be used. The manufacturer of the equipment in which the non-conductive hose is to be used must be consulted to be certain that the hose and fittings that are selected are proper for the application.

Do not use any ALFAGOMMA hose or fitting for any application requiring non-conductive hose, including but not limited to applications near high voltage electric lines, unless the application is expressly approved in the ALFAGOMMA technical publication for the product, the SAFETY GUIDE hose is both orange in colour and marked "non-conductive", and the manufacturer of the equipment on which the hose is to be used specifically approves the particular ALFAGOMMA hose and fitting for such use.

ALFAGOMMA does not supply any hose or fittings for conveying paint in airless paint spraying or similar applications and therefore should not be used. A special hose and fitting assembly is required for this application, to avoid static electricity buildup which could cause a spark that may result in an explosion and/or fire.

The electrical conductivity or non-conductivity of hose and fittings is dependant upon many factors and may be susceptible to change. These factors include but are not limited to the various materials used to make the hose and the fittings, manufacturing methods (including moisture control), how the fittings contact the hose, age and amount of deterioration or damage or other changes, moisture content of the hose at and particular time, and others factors.

2. INSTALLATION

After the selection of the correct hose, the following factors must be considered prior to hose and fitting assembly and installation.

2.1 Pre-Installation Inspection

Prior to installation, a careful examination of the hose must be performed. All components must be checked for correct style, size, and length. The hose must be examined for cleanliness, obstructions, blisters, cover looseness, or any other visible defects.

2.2 Hose and Fitting Assembly

Do not assemble an ALFAGOMMA fitting on an ALFAGOMMA hose that is not specified by ALFAGOMMA for that hose. Do not assemble ALFAGOMMA fittings on another manufacturer's hose or an ALFAGOMMA hose on another manufacturer's fitting unless ALFAGOMMA approves the assembly in writing, and the user verifies the assembly and the application through analysis and testing.

The ALFAGOMMA published hose assembly instructions must be followed for assembling the fittings on the hose.

2.3 Related Accessories

Crimp or swage ALFAGOMMA hose or fittings only with ALFAGOMMA approved swage or crimp machines and in accordance with the ALFAGOMMA published hose assembly instructions.

2.4 Parts:

Do not use any ALFAGOMMA hose fitting part (including but not limited to sockets, or inserts) except with the correct ALFAGOMMA mating parts, in accordance with ALFAGOMMA published hose assembly.

2.5 Reusable/Permanent

Do not reuse any reusable hose coupling that has blown or pulled off a hose. Do not reuse an ALFAGOMMA permanent (that is, crimped or swaged) hose fitting or any part thereof.

2.6 Minimum Bend Radius

Installation of a hose at less than the minimum listed bend radius may significantly reduce the hose life. Particular attention must be given to avoid sharp bending at the hose/fitting juncture.

2.7 Twist Angle and Orientation

Hose installations must be such that relative motion of machine components does not produce twisting.

2.8 Securement

In many applications, it may be necessary to restrain, protect, or guide the hose to protect it from damage by unnecessary flexing, pressure surges, and contact with other mechanical components. Care must be taken to ensure such restraints do not introduce additional stress or wear points.

2.9 Proper Connection of Ports

Proper physical installation of the hose requires a correctly installed port connection while ensuring that no twist or torque is transferred to the hose.

2.10 External Damage

Proper installation is not complete without ensuring that tensile loads, side loads, kinking, flattening, potential abrasion, thread damage, or damage to sealing surfaces are corrected or eliminated.

2.11 System Checkout

After completing the installation all air entrapment must be eliminated and the system pressurised to the maximum system pressure and checked for proper function without any leaks. Personnel must stay out of potential hazardous areas while testing.

3. HOSE AND FITTING MAINTENANC INSTRUCTIONS

Even with proper selection and installation, hose life may be significantly reduced without a continuing maintenance program. Frequency should be determined by the severity of the application and risk potential. A maintenance program must be established and followed to include the following as a minimum:

3.1 Visual Inspection Hose/Fitting

Any of the following conditions require immediate shut down and replacement of the hose assembly:

- Fitting slippage on hose.
- Damaged, cut or abraded cover (any reinforcement exposed).
- Hard, stiff, heat cracked, or charred hose.
- Cracked, damaged, or badly corroded fittings.
- Leaks at fitting or in hose.
- Kinked, crushed, flattened or twisted hose.
- Blistered, soft, degraded, or loose cover.

3.2 Visual Inspection All Other

The following items must be tightened, repaired or replaced as required:

- Leaking port conditions
- Remove excess dirt build-up
- Clamp, guards, shields
- System fluid level, fluid type and any air entrapment

3.3 Functional Test

Operate the system at maximum operating pressure and check for possible malfunctions and freedom from leaks. Personnel must stay out of potential hazardous areas while testing.

3.4 Replacement Intervals

Specific replacement intervals must be considered based on previous service life, government or industry recommendations, or when failures could result in unacceptable downtime, damage, or injury risk.

CORRECT ASSEMBLY INSTALLATION

Satisfactory performance and appearance depend upon proper hose installation. Excessive length destroys the trim appearance of an installation and adds unnecessarily to the cost of the equipment. Hose assemblies of insufficient length to permit adequate flexing, expansion or contraction will cause poor power transmission and shorten the life of the hose.

The diagrams below offer suggestions for proper hose installations to obtain the maximum in performance and economy.

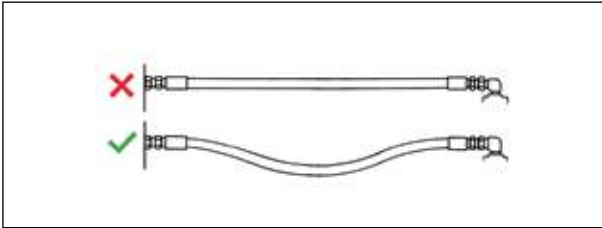

Since hose may change in length from +2% to -4% under the surge of high pressure, provide sufficient slack for expansion and contraction.



Avoid sharp twist or bend in hose by using proper angle adapters.



Where the radius falls below the required minimum, an angle adapter should be used as shown above to avoid sharp bends in hose.

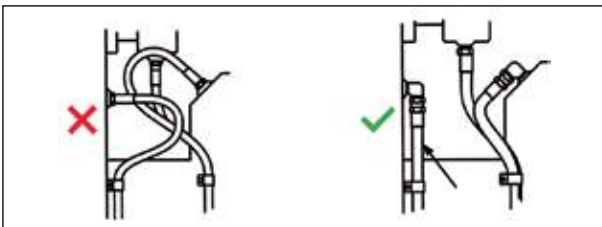

Obtain direct routing of hose through use of 45° and 90° adapters and fittings. Improve appearance by avoiding excessive hose length.

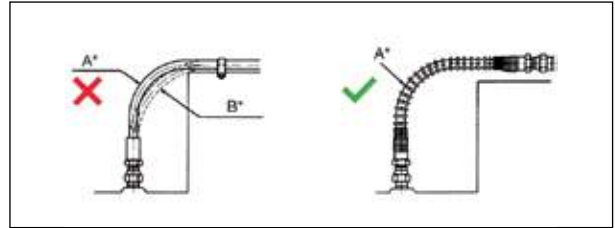

A: High Pressure - B: No Pressure

Due to changes in length when hose is pressurised, do not clamp at bends so curves absorb changes and protect the hose with a spring guard. Do not clamp high and low pressure lines together and protect the hose with a spring guard.

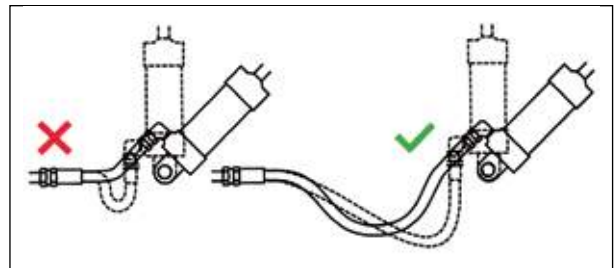

Adequate hose length is most important to distribute movement on flexing applications and to avoid abrasion.

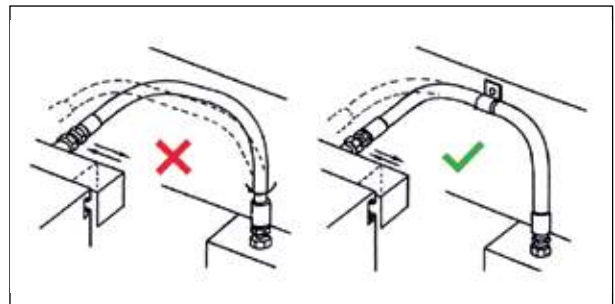

To avoid twisting in hose lines bent in two planes, clamp hose at change of plane, as shown.

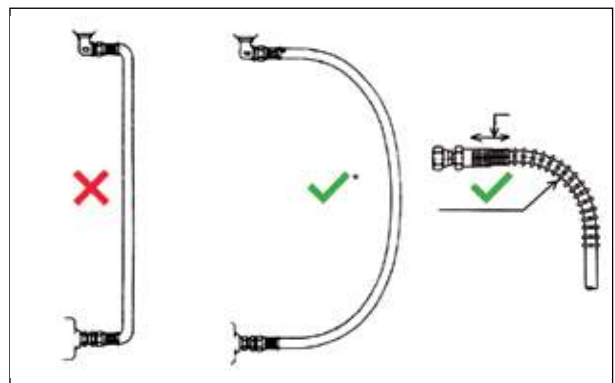

* Never use a banding radius less than the minimum amount shown in the table.

To prevent twisting and distortion, hose should be bent in the same plane as the motion of the boss to which the hose is connected.

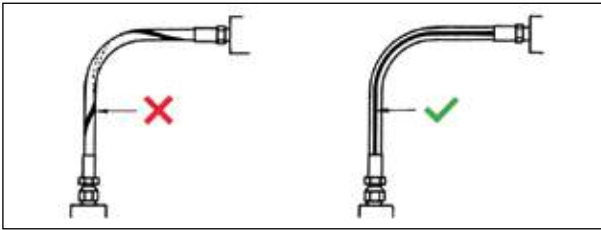

Hose should not be twisted. Hose is weakened when installed in twisted position. Also pressure in twisted hose tends to loosen fitting connections. Design so that machine motion produces bending rather than twisting.

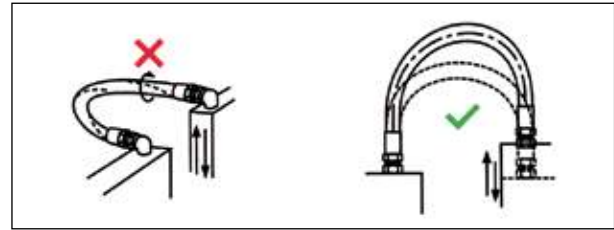

Never use a bending radius less than the minimum shown in the hose specification tables. Avoid sharp bend in hose to reduce collapsing of line and restriction of flow by using proper spring guard. Exceeding minimum bend radius will greatly reduce hose assembly life.

HOW TO DETERMINE CORRECT ASSEMBLY LENGTH

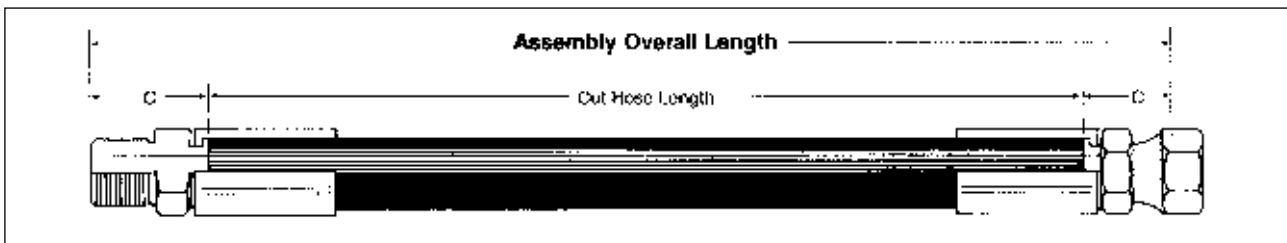

For most assemblies, the correct assembly length may be determined by direct measurement of the equipment or a drawing. Minimum bend radii as shown in the hose specification tables should be observed. Assemblies are measured to the end of the seal.

To determine the length of hose needed in making assemblies with permanent or reusable couplings, subtract Dimension "C" (Cut off factor) for each coupling from the required overall assembly length. Dimension "C" may be found in the coupling specification tables.

HOW TO MEASURE ASSEMBLIES

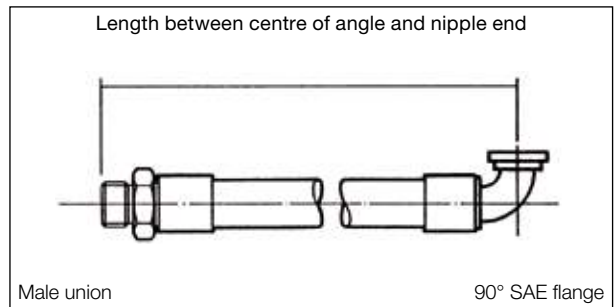
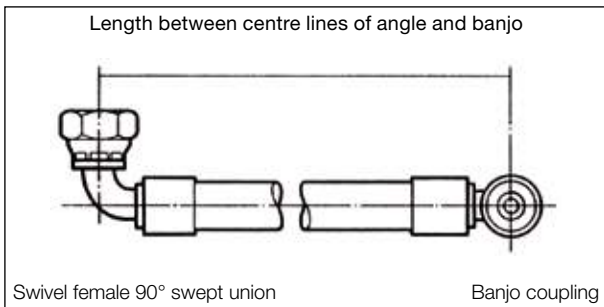
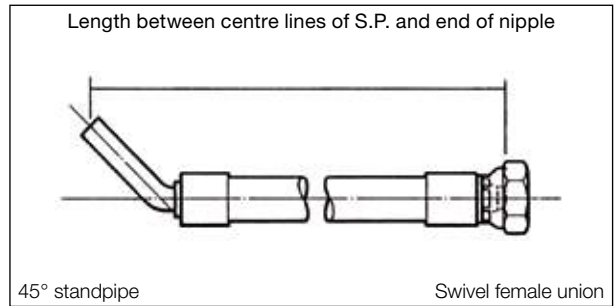
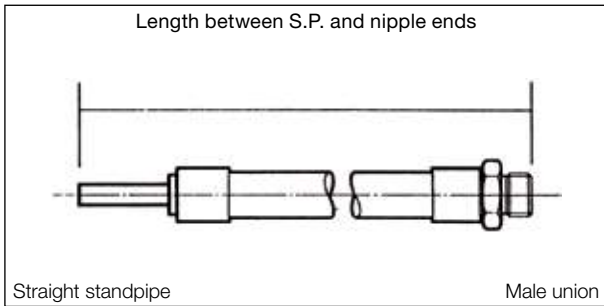
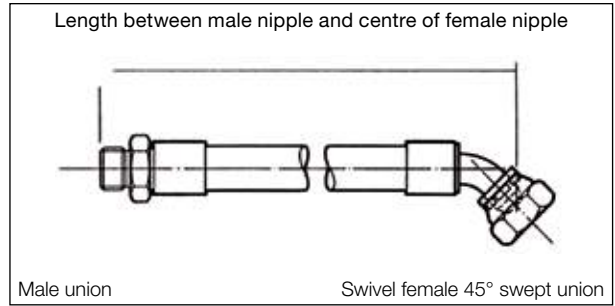
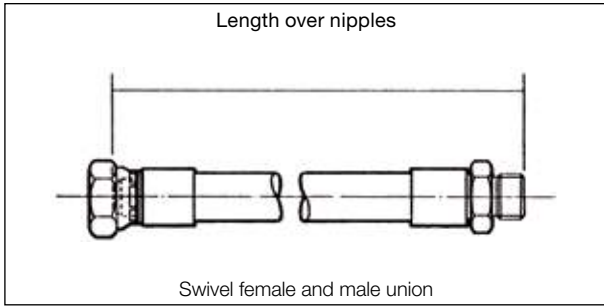

Remember that hydraulic hose under pressure will elongate up to 2% of its length or contract up to 4% depending on pressure, type and size. Sufficient allowance should be made to permit such changes in length.

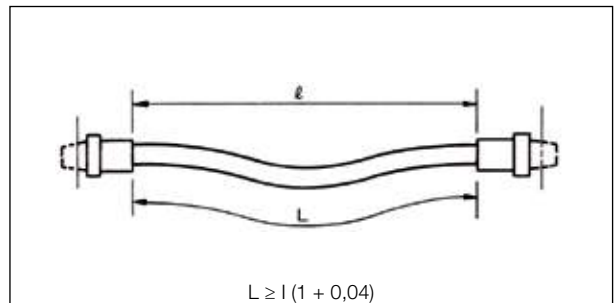

Occasionally an assembly will be required similar to the sketches to the right. The following equations are helpful in determining the correct length:

FOR 180° TURN APPLICATIONS

#1 $L = 2A + \pi R$

#2 $L = 2A + \pi R + T$

where:

L=overall length of the hydraulic hose assembly, in mm or inches.

A=allowance for a minimum straight section of hydraulic hose at each end of the assembly, measured from the outer end of each coupling, in mm or inches. These two straight sections are necessary to prevent excessive stress concentrations directly back of the couplings. See table below.

R=bending radius of the hose, in mm or inches. See hose specifications tables.

T=amount of travel, in mm or inches.

Often right angle adapters provide a convenient means of avoiding too small a bend radius.

Hose ID	in	1/4	5/16	3/8	1/2	5/8	3/4	1	1.1/4	1.1/2	2
	mm	6,4	7,9	9,5	12,7	15,9	19	25	31,8	38,1	50,8
Min "A"	in	5	5	5	6	6	7	8	9	10	11
	mm	127	127	127	152	152	178	203	229	254	279

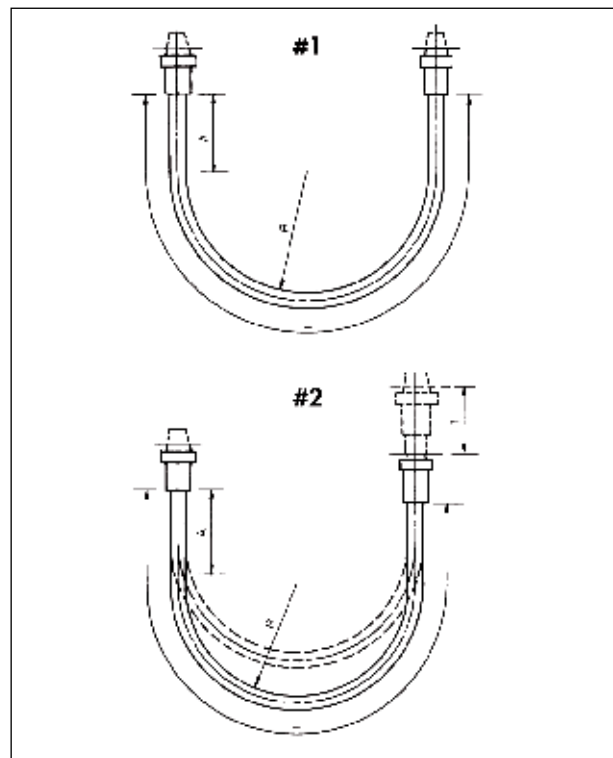

Length Tolerance for Hydraulic Hose Assemblies and Specified Hose Lengths

Length

For lengths from 0 up to and including 12" (305 mm)

For lengths ≥ 12" (305 mm) < 18" (457 mm)

For lengths ≥ 18" (457 mm) < 36" (914 mm)

For lengths ≥ 36" (914 mm) < 48" (1219 mm)

For lengths ≥ 48" (1219 mm) < 72" (1830 mm)

For lengths ≥ 72" (1830 mm)

Tolerance

± 1/8" ± 3 mm

± 3/16" ± 5 mm

± 1/4" ± 6 mm

± 3/8" ± 10 mm

± 1/2" ± 13 mm

± 1%

Elbow angle and angle of orientation

Tolerance ±3

Angle Couplings

A - To measure angle of offset of a hose assembly, point one end of coupling "A" (the nearest) to a vertical position downward. The angle can then be measured from the centreline of this vertical coupling in an anticlockwise direction to the centreline of coupling "B" (the far coupling) (see illustration).

Relationships can then be expressed from 0° to 360°. If angle not given elbows are positioned at 0°.

